

Glastender®

A family company manufacturing in the USA

www.glastender.com



DWB-14-C



Intertek

4004503

Conforms to ANSI/NSF STD 2

Specifications

Legs (DWB-12 excluded)

- 1-5/8" diameter, 16 gauge stainless steel
- Adjustable stainless steel bullet feet for total leg height of 6" to 7-1/4" for DWB-14-C† or 16" to 17-1/4" for DWB-15L/DWB-15R

Materials

- 20 gauge stainless steel



DWB-12

(shown in an installation setting with optional trash receptacle)



DWB-15L

(shown in an installation setting with optional trash receptacle)



DWB-14-C†

(shown with top removed)

Underbar installation instructions: <https://www.glastender.com/support/documents/manuals/underbar-installation-instructions>

Cleaning & care instructions: <https://www.glastender.com/support/documents/manuals/general-cleaning-and-care-instructions-for-stainless-steel>

Project: _____	AIA# _____
Item #: _____ Qty: _____	SIS# _____
Model #: _____	

Dry Waste Chutes

Patent Pending†

DWB

DWB-12, DWB-14-C†, DWB-15L, DWB-15R

Standard Features

- All stainless steel
- Lift-off top for trash receptacle removal and cleaning
- 30" high work surface
- DWB-12 has no legs; must be bridge mounted between underbar
- DWB-14-C† is free standing with two leg sets and hinged access door
- DWB-15L and DWB-15R have one leg set; must be side mounted to underbar

Configurable Options

- Side splashes; specify option LSDW (left) and/or RSDW (right) for DWB-14-C†

Accessories

03000497 Rubbermaid Slim Jim® trash receptacle

Glastender, Inc. • 5400 N Michigan Rd • Saginaw, MI • 48604-9780
989.752.4275 • 800.748.0423 • Fax 989.752.4444
www.glastender.com

Approval/Notes:

Specifications subject to change without notice. For current specifications please visit our website.

Dry Waste Chutes

Drawings

DWB-12

SIDE ELEVATIONS

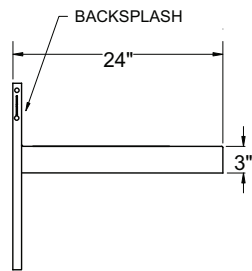

FRONT ELEVATIONS

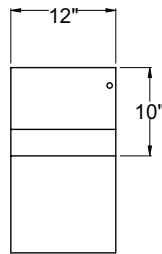

PLAN VIEWS

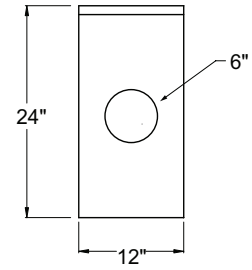

DWB-14-C†

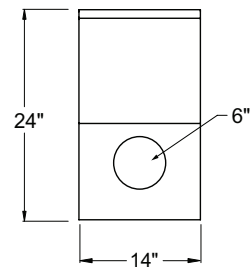
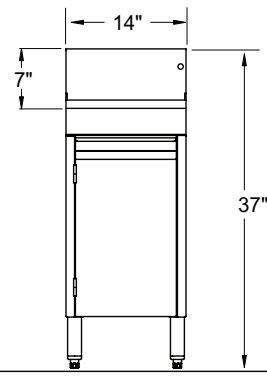
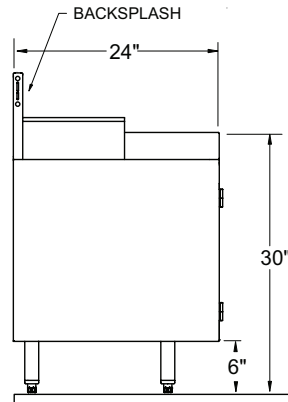

DWB-15L

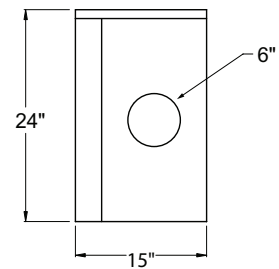
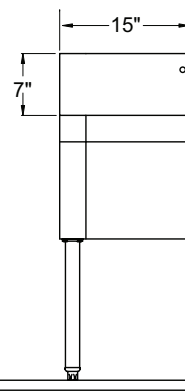
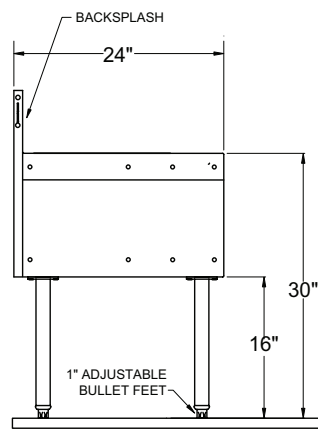

DWB-15R

